

ENTRANCE SYSTEMS

Melton Classics offers a wide array of classic entry system features to allow the designer to create just the right entrance for any design. Any doorway can be enhanced by combining pilasters, crossheads and pediments from our broad selection of standard molds. Pilasters are available in plain, fluted and paneled shaft designs to beautifully frame your door or window opening. Arch mouldings with or without keystones are also available in flat or moulded profiles with matching casings to enhance the beauty of radius door and window transoms.

TOWN ENTRANCE SYSTEMS

Town Entrance Systems are low cost reproductions of colonial millwork that will enhance the most basic house. The crossheads and pediments are molded as one complete unit to save installation time and eliminate water infiltration. Melton Classics offers several different pilaster styles and sizes to choose from to meet your needs. The pilasters butt to the bottom of the crosshead and can be adjusted to varying jamb conditions as well as height requirements.

SINGLE ENTRANCE SYSTEMS

The Single Entrance Systems are made to enhance every home. The Single Series provides more depth of projection and detail than our Town

Series. We add Capitals and backer boards to the pilasters as well as larger crown moldings and details to the crossheads and pediments. We combine the crossheads and pediments into one unit to save installation time and eliminate water infiltration. The single series offers pilaster widths from 6" to 10" to accommodate most every application. The pilasters butt to the bottom of the crosshead and can be adjusted to varying jamb conditions as well as height requirements.

CUSTOM ENTRANCE SYSTEMS

The Custom Series is geared for large custom homes or commercial projects. Massive details are incorporated with architecturally correct proportion to achieve entrances of a grand scale. Pilasters are offered in widths of 10", 11" and 12" and in

heights up to 12 feet. Melton Classics adds a Broken Bonnet, Swelled Crosshead and a Triglyph Crosshead to this Line. The pilasters butt to the bottom of the crosshead and can be adjusted to varying jamb conditions as well as height requirements.

SPECIALTY ENTRANCE SYSTEMS

Specialty Entrances have been carefully designed with the finest detail and craftsmanship. These classic designs will add style and elegance to any home.



entrance systems

SINGLE SERIES

Order Instructions

Step 1 Determine the "D" Dimension. This is the distance between the inside edge of your pilasters as they will be installed on the door jamb. (SEE DETAIL 1)

Step 2 Locate the Crosshead and Pediment Selection Chart (Page 25 & 26). Under Pilaster Widths, locate your "D" Dimension (See sample at bottom of page). If your "D" Dimension does not match exactly, there are 2 options below (A and B).

A) Select the next largest "D" Dimension, which will usually result in the crosshead overhanging the pilasters by an inch or less on either side. (Example: If your "D" Dimension is 35 1/2" select 36").

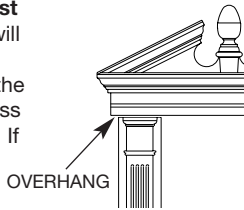

B) Look to see if a "D" Dimension in another column matches your requirements. If so, this will require changing the width of the pilasters as noted at the top of the column above the located "D" Dimension.

Step 3 To select a crosshead and pediment that will work with the "D" Dimension and pilaster width, move to the right, under the heading "Description". There you will locate the different style crossheads and crossheads & pediments available to fit your application.

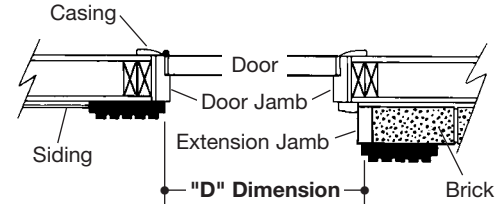

DETAIL 1

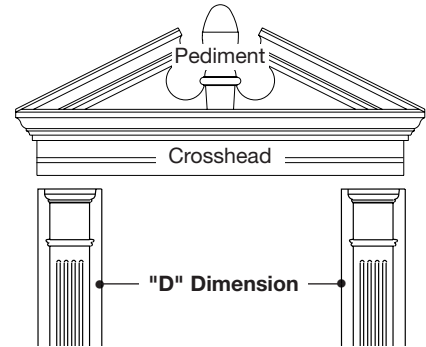

Step 4 Locate the Pilaster Selection Chart (Pages 27 and 28). Using the width as determined by your "D" Dimension, select the style and height as required by your application.

Refer to page 24 & 25 for drawings of Crossheads & Combo Crossheads & Pediments.

SAMPLE - Crossheads & Combination Crossheads/Pediments Selection Chart

| PILASTER WIDTHS | | | | | | | | | Description | Item No. |
|--------------------|----|----|----|----|-----|-----|-----|--|------------------------|------------|
| 5" | 6" | 7" | 8" | 9" | 10" | 11" | 12" | | | |
| SINGLE DOOR | | | | | | | | | | |
| | | | | | | | | | Crosshead w/Trim Strip | 350-110-10 |
| | | | | | | | | | Crosshead w/Trim Strip | 350-110-15 |
| | | | | | | | | | Combo Acorn | 350-110-20 |
| | | | | | | | | | Combo Sunburst | 350-110-25 |
| | | | | | | | | | Combo Plain | 350-110-30 |
| | | | | | | | | | Combo Peak | 350-110-35 |
| | | | | | | | | | Combo Rams Head | 350-110-40 |
| | | | | | | | | | Combo Broken Bonnet | 350-110-45 |
| | | | | | | | | | Crosshead w/Trim Strip | 350-120-10 |
| | | | | | | | | | Crosshead w/Trim Strip | 350-120-15 |
| | | | | | | | | | Combo Acorn | 350-120-20 |
| | | | | | | | | | Combo Sunburst | 350-120-25 |
| | | | | | | | | | Combo Plain | 350-120-30 |

Step 2

Step 2

"D" DIMENSIONS

Step 3

"D" DIMENSIONS

entrance systems

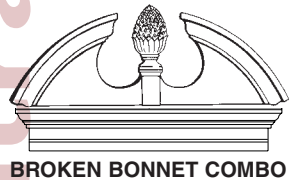
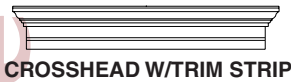
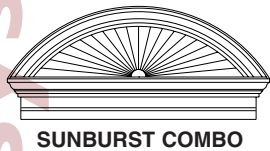

SINGLE SERIES

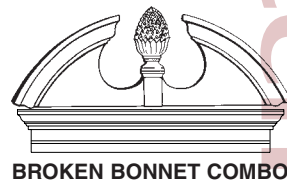
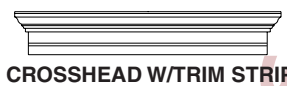
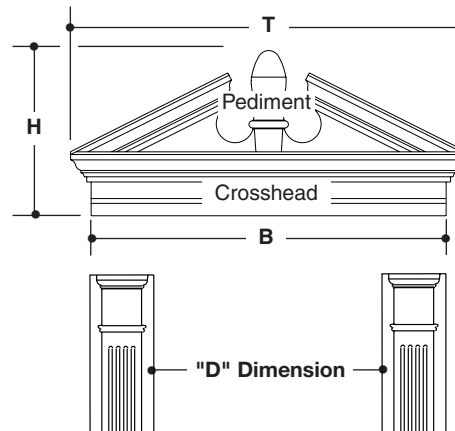

SELECTION CHART for Crossheads & Combination Crossheads/Pediments

| PILASTER WIDTHS | | | | | | Description | Item No. | Bottom Width "B" | Top Width "T" | Height "H" | Proj. "P" |
|--|----|----|----|----|-----|------------------------|------------|------------------|----------------------------------|----------------------------------|-----------|
| 5" | 6" | 7" | 8" | 9" | 10" | | | | | | |
| SINGLE DOOR | | | | | | | | | | | |
| "D" DIMENSIONS 40" 38" 36" 34" 32" 30" | | | | | | Crosshead w/Trim Strip | 350-200-10 | 50" | 55 ³ / ₄ " | 9" | 4" |
| | | | | | | Crosshead w/Trim Strip | 350-200-15 | | | 11" | |
| | | | | | | Combo Acorn | 350-200-20 | | | 23" | |
| | | | | | | Combo Sunburst | 350-200-25 | | | 23" | |
| | | | | | | Combo Plain | 350-200-30 | | | 23" | |
| | | | | | | Combo Peak | 350-200-35 | | | 23" | |
| | | | | | | Combo Rams Head | 350-200-40 | | | 29" | |
| | | | | | | Combo Broken Bonnet | 350-200-45 | | | 27" | |
| "D" DIMENSIONS 44" 42" 40" 38" 36" 34" | | | | | | Crosshead w/Trim Strip | 350-210-10 | 54" | 59 ³ / ₄ " | 9" | 4" |
| | | | | | | Crosshead w/Trim Strip | 350-210-15 | | | 11" | |
| | | | | | | Combo Acorn | 350-210-20 | | | 24" | |
| | | | | | | Combo Sunburst | 350-210-25 | | | 24" | |
| | | | | | | Combo Plain | 350-210-30 | | | 24" | |
| | | | | | | Combo Peak | 350-210-35 | | | 24" | |
| | | | | | | Combo Rams Head | 350-210-40 | | | 30" | |
| | | | | | | Combo Broken Bonnet | 350-210-45 | | | 28" | |
| SINGLE DOOR & SINGLE DOOR w/SIDELIGHT | | | | | | | | | | | |
| "D" DIMENSIONS 50" 48" 46" 44" 42" 40" | | | | | | Crosshead w/Trim Strip | 350-220-10 | 60" | 65 ³ / ₄ " | 9" | 4" |
| | | | | | | Crosshead w/Trim Strip | 350-220-15 | | | 11" | |
| | | | | | | Combo Acorn | 350-220-20 | | | 25 ¹ / ₂ " | |
| | | | | | | Combo Sunburst | 350-220-25 | | | 25 ¹ / ₂ " | |
| | | | | | | Combo Plain | 350-220-30 | | | 25 ¹ / ₂ " | |
| | | | | | | Combo Peak | 350-220-35 | | | 25 ¹ / ₂ " | |
| | | | | | | Combo Rams Head | 350-220-40 | | | 31 ¹ / ₂ " | |
| | | | | | | Combo Broken Bonnet | 350-220-45 | | | 29 ¹ / ₂ " | |
| "D" DIMENSIONS 56" 54" 52" 50" 48" 46" | | | | | | Crosshead w/Trim Strip | 350-230-10 | 66" | 71 ³ / ₄ " | 9" | 4" |
| | | | | | | Crosshead w/Trim Strip | 350-230-15 | | | 11" | |
| | | | | | | Combo Acorn | 350-230-20 | | | 27" | |
| | | | | | | Combo Sunburst | 350-230-25 | | | 27" | |
| | | | | | | Combo Plain | 350-230-30 | | | 27" | |
| | | | | | | Combo Peak | 350-230-35 | | | 27" | |
| | | | | | | Combo Rams Head | 350-230-40 | | | 33" | |
| | | | | | | Combo Broken Bonnet | 350-230-45 | | | 31" | |

* NOTE: For a 9" & 11" Crosshead with Keystone, add keystone no. after item no. Example: 350-230-10/1155-130.

entrance systems

SINGLE SERIES

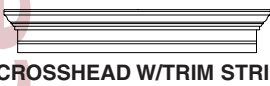
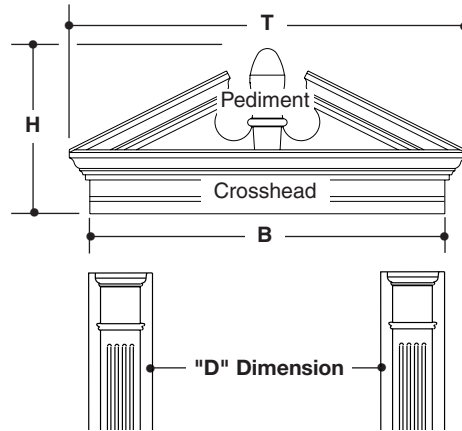

SELECTION CHART for Crossheads & Combination Crossheads/Pediments

| PILASTER WIDTHS | | | | | | Description | Item No. | Bottom Width "B" | Top Width "T" | Height "H" | Proj. "P" |
|---|-----|-----|-----|-----|-----|--|--|------------------|----------------------------------|------------|-----------|
| 5" | 6" | 7" | 8" | 9" | 10" | | | | | | |
| SINGLE DOOR with 2 SIDELIGHTS & DOUBLE DOORS | | | | | | | | | | | |
| "D" DIMENSIONS | | | | | | Crosshead w/Trim Strip Crosshead w/Trim Strip Combo Acorn Combo Sunburst Combo Plain Combo Peak Combo Rams Head Combo Broken Bonnet | 350-240-10 350-240-15 350-240-20 350-240-25 350-240-30 350-240-35 350-240-40 350-240-45 | 78" | 83 ³ / ₄ " | 9" | 4" |
| 68" | 66" | 64" | 62" | 60" | 58" | | | | | 11" | |
| | | | | | | | | | | 30" | |
| | | | | | | | | | | 30" | |
| | | | | | | | | | | 30" | |
| | | | | | | | | | | 30" | |
| | | | | | | | | | | 36" | |
| | | | | | | | | | | 34" | |
| "D" DIMENSIONS | | | | | | Crosshead w/Trim Strip Crosshead w/Trim Strip Combo Acorn Combo Sunburst Combo Plain Combo Peak) Combo Rams Head Combo Broken Bonnet | 350-250-10 350-250-15 350-250-20 350-250-25 350-250-30 350-250-35 350-250-40 350-250-45 | 82" | 87 ³ / ₄ " | 9" | 4" |
| 72" | 70" | 68" | 66" | 64" | 62" | | | | | 11" | |
| | | | | | | | | | | 31" | |
| | | | | | | | | | | 31" | |
| | | | | | | | | | | 31" | |
| | | | | | | | | | | 31" | |
| | | | | | | | | | | 37" | |
| | | | | | | | | | | 35" | |
| "D" DIMENSIONS | | | | | | Crosshead w/Trim Strip Crosshead w/Trim Strip Combo Acorn Combo Sunburst Combo Plain Combo Peak Combo Rams Head Combo Broken Bonnet | 350-260-10 350-260-15 350-260-20 350-260-25 350-260-30 350-260-35 350-260-40 350-260-45 | 86" | 91 ³ / ₄ " | 9" | 4" |
| 76" | 74" | 72" | 70" | 68" | 66" | | | | | 11" | |
| | | | | | | | | | | 32" | |
| | | | | | | | | | | 32" | |
| | | | | | | | | | | 32" | |
| | | | | | | | | | | 32" | |
| | | | | | | | | | | 38" | |
| | | | | | | | | | | 36" | |
| "D" DIMENSIONS | | | | | | Crosshead w/Trim Strip Crosshead w/Trim Strip Combo Acorn Combo Sunburst Combo Plain Combo Peak Combo Rams Head Combo Broken Bonnet | 350-270-10 350-270-15 350-270-20 350-270-25 350-270-30 350-270-35 350-270-40 350-270-45 | 94" | 99 ³ / ₄ " | 9" | 4" |
| 84" | 82" | 80" | 78" | 76" | 74" | | | | | 11" | |
| | | | | | | | | | | 34" | |
| | | | | | | | | | | 36" | |
| | | | | | | | | | | 34" | |
| | | | | | | | | | | 34" | |
| | | | | | | | | | | 40" | |
| | | | | | | | | | | 38" | |

* NOTE: For a 9" & 11" Crosshead with Keystone, add keystone no. after item no. **Example: 350-270-10/1155-130.**

SINGLE SERIES

**351-200
FLUTED
PILASTER**

351-200 & 351-220
Pilasters (stock sizes: 120" and 144") are supplied with loose plinth blocks and can be cut on the job site to accommodate sizes 91" to 120" & 121" to 144".

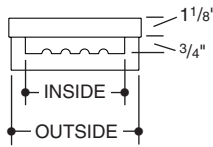

| OUTSIDE | INSIDE |
|---------|---------------------------------|
| 5" | 3 ³ / ₄ " |
| 6" | 4 ¹ / ₂ " |
| 7" | 5 ¹ / ₄ " |
| 8" | 6" |
| 9" | 6 ³ / ₄ " |
| 10" | 7 ¹ / ₂ " |

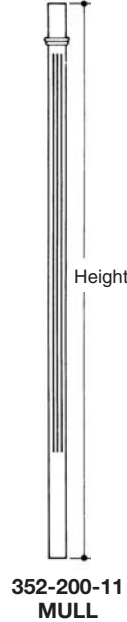
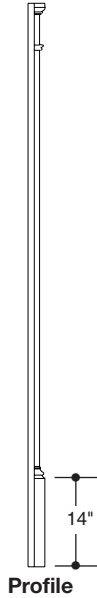

351-200 Pilaster Selection Chart

| ITEM NO. | WIDTH | STOCK HEIGHT | CUSTOM HEIGHT |
|-----------------|-------|--------------|---------------|
| 351-200-5-90 | 5" | 90" | - |
| 351-200-5-120* | 5" | 120" | 91"-120" |
| 351-200-6-90 | 6" | 90" | - |
| 351-200-6-120* | 6" | 120" | 91"-120" |
| 351-200-7-90 | 7" | 90" | - |
| 351-200-7-102* | 7" | 102" | - |
| 351-200-7-116* | 7" | 116" | - |
| 351-200-7-120* | 7" | 120" | 91"-120" |
| 351-200-7-144* | 7" | 144" | 121"-144" |
| 351-200-8-73* | 8" | 73" | - |
| 351-200-8-90 | 8" | 90" | - |
| 351-200-8-120* | 8" | 120" | 91"-120" |
| 351-200-8-144* | 8" | 144" | 121"-144" |
| 351-200-9-90 | 9" | 90" | - |
| 351-200-9-102* | 9" | 102" | - |
| 351-200-9-120* | 9" | 120" | 91"-120" |
| 351-200-9-144* | 9" | 144" | 121"-144" |
| 351-200-10-90 | 10" | 90" | - |
| 351-200-10-120* | 10" | 120" | 91"-120" |
| 351-200-10-144* | 10" | 144" | 121"-144" |

* Supplied with loose plinth blocks.

Mulls

| ITEM NO. | WIDTH | HEIGHT |
|------------|-------|--------|
| 352-200-11 | 2" | 84" |

**351-210
PANEL
PILASTER**

351-210 Pilasters are made with fixed plinth blocks. The bottom of the plinth block can be cut to adjust the height.

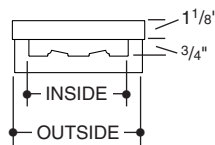

| OUTSIDE | INSIDE |
|---------|---------------------------------|
| 7" | 5 ¹ / ₄ " |
| 8" | 6" |
| 9" | 6 ³ / ₄ " |
| 10" | 7 ¹ / ₂ " |

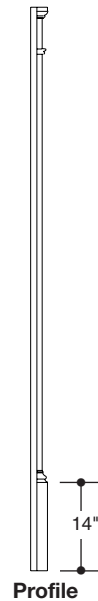
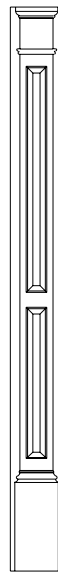

351-210 Pilaster Selection Chart

| ITEM NO. | WIDTH | STOCK HEIGHT |
|----------------|-------|--------------|
| 351-210-7-90 | 7" | 90" |
| 351-210-7-120 | 7" | 120" |
| 351-210-8-90 | 8" | 90" |
| 351-210-8-120 | 8" | 120" |
| 351-210-9-90 | 9" | 90" |
| 351-210-9-102 | 9" | 102" |
| 351-210-9-120 | 9" | 120" |
| 351-210-10-90 | 10" | 90" |
| 351-210-10-108 | 10" | 108" |
| 351-210-10-120 | 10" | 120" |
| 351-210-10-144 | 10" | 144" |

entrance systems



SINGLE SERIES

entrance systems

**351-220
PLAIN
PILASTER**

*351-200 & 351-220 Pilasters
(stock sizes: 120" and 144")
are supplied with loose plinth
blocks and can be cut on the
job site to accomodate sizes
91" to 120" & 121" to 144".*

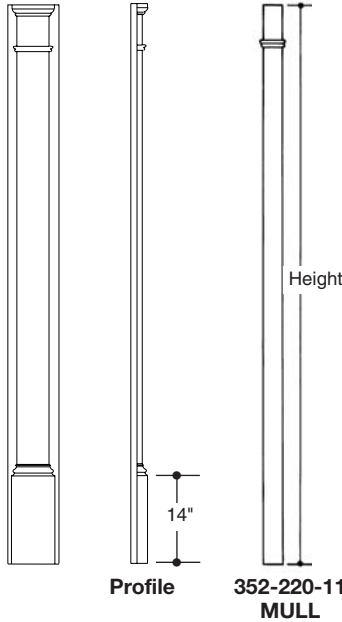
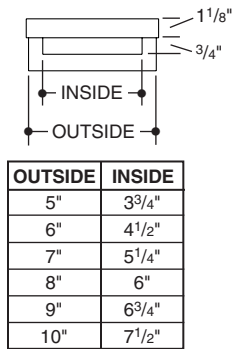

351-220 Pilaster Selection Chart

| ITEM NO. | WIDTH | STOCK HEIGHT | CUSTOM HEIGHT |
|-----------------|-------|--------------|---------------|
| 351-220-5-90 | 5" | 90" | - |
| 351-220-5-120* | 5" | 120" | 91"-120" |
| 351-220-6-90 | 6" | 90" | - |
| 351-220-6-120* | 6" | 120" | 91"-120" |
| 351-220-7-90 | 7" | 90" | - |
| 351-220-7-120* | 7" | 120" | 91"-120" |
| 351-220-7-144* | 7" | 144" | 121"-144" |
| 351-220-8-90 | 8" | 90" | - |
| 351-220-8-120* | 8" | 120" | 91"-120" |
| 351-220-8-144* | 8" | 144" | 121"-144" |
| 351-220-9-90 | 9" | 90" | - |
| 351-220-9-120* | 9" | 120" | 91"-120" |
| 351-220-9-144* | 9" | 144" | 121"-144" |
| 351-220-10-90 | 10" | 90" | - |
| 351-220-10-120* | 10" | 120" | 91"-120" |
| 351-220-10-144* | 10" | 144" | 121"-144" |

* Supplied with loose plinth blocks.

Mulls

| ITEM NO. | WIDTH | HEIGHT |
|------------|-------|--------|
| 352-220-11 | 2" | 84" |

**351-230
PLAIN
PANEL
PILASTER**

*351-230 Pilasters are
made with fixed plinth
blocks. The bottom of the
plinth block can be cut to
adjust the height.*

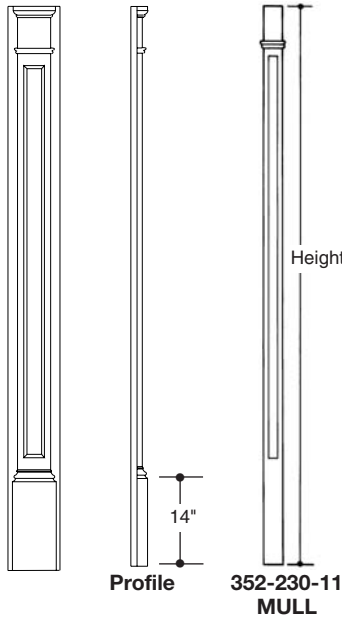
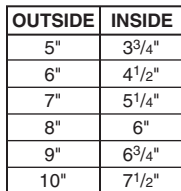

**351-263 Pilaster
Selection Chart**

| ITEM NO. | WIDTH | STOCK HEIGHT |
|----------------|-------|--------------|
| 351-230-5-90 | 5" | 90" |
| 351-230-6-90 | 6" | 90" |
| 351-230-7-90 | 7" | 90" |
| 351-230-7-120 | 7" | 120" |
| 351-230-8-90 | 8" | 90" |
| 351-230-8-120 | 8" | 120" |
| 351-230-9-90 | 9" | 90" |
| 351-230-9-102 | 9" | 102" |
| 351-230-9-120 | 9" | 120" |
| 351-230-10-90 | 10" | 90" |
| 351-230-10-108 | 10" | 108" |
| 351-230-10-120 | 10" | 120" |
| 351-230-10-144 | 10" | 144" |

Mulls

| ITEM NO. | WIDTH | HEIGHT |
|------------|-------|--------|
| 352-230-11 | 2" | 84" |

**353-200/353-220
LOOSE PLINTH**

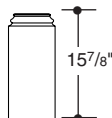

Loose Plinths

| ITEM NO. | WIDTH | HEIGHT |
|-----------------------|-------|---------|
| 353-200-5/353-220-5 | 5" | 15-7/8" |
| 353-200-6/353-220-6 | 6" | |
| 353-200-7/353-220-7 | 7" | |
| 353-200-8/353-220-8 | 8" | |
| 353-200-9/353-220-9 | 9" | |
| 353-200-10/353-220-10 | 10" | |

NOTE: Specify 353-200-() or 353-220-().