

ENTRANCE SYSTEMS

Melton Classics offers a wide array of classic entry system features to allow the designer to create just the right entrance for any design. Any doorway can be enhanced by combining pilasters, crossheads and pediments from our broad selection of standard molds. Pilasters are available in plain, fluted and paneled shaft designs to beautifully frame your door or window opening. Arch mouldings with or without keystones are also available in flat or moulded profiles with matching casings to enhance the beauty of radius door and window transoms.

TOWN ENTRANCE SYSTEMS

Town Entrance Systems are low cost reproductions of colonial millwork that will enhance the most basic house. The crossheads and pediments are molded as one complete unit to save installation time and eliminate water infiltration. Melton Classics offers several different pilaster styles and sizes to choose from to meet your needs. The pilasters butt to the bottom of the crosshead and can be adjusted to varying jamb conditions as well as height requirements.

SINGLE ENTRANCE SYSTEMS

The Single Entrance Systems are made to enhance every home. The Single Series provides more depth of projection and detail than our Town

Series. We add Capitals and backer boards to the pilasters as well as larger crown moldings and details to the crossheads and pediments. We combine the crossheads and pediments into one unit to save installation time and eliminate water infiltration. The single series offers pilaster widths from 6" to 10" to accommodate most every application. The pilasters butt to the bottom of the crosshead and can be adjusted to varying jamb conditions as well as height requirements.

CUSTOM ENTRANCE SYSTEMS

The Custom Series is geared for large custom homes or commercial projects. Massive details are incorporated with architecturally correct proportion to achieve entrances of a grand scale. Pilasters are offered in widths of 10", 11" and 12" and in

heights up to 12 feet. Melton Classics adds a Broken Bonnet, Swelled Crosshead and a Triglyph Crosshead to this Line. The pilasters butt to the bottom of the crosshead and can be adjusted to varying jamb conditions as well as height requirements.

SPECIALTY ENTRANCE SYSTEMS

Specialty Entrances have been carefully designed with the finest detail and craftsmanship. These classic designs will add style and elegance to any home.



entrance systems

TOWN SERIES

Order Instructions

Step 1 Determine the "D" Dimension. This is the distance between the inside edge of your pilasters as they will be installed on the door jamb. (SEE DETAIL 1)

Step 2 Locate the Crosshead and Pediment Selection Chart (Page 21). Under Pilaster Widths, locate your "D" Dimension (See sample at bottom of page). If your "D" Dimension does not match exactly, there are 2 options below (A and B).

A) Select the next largest "D" Dimension, which will usually result in the crosshead overhanging the pilasters by an inch or less on either side. (Example: If your "D" Dimension is 35 1/2" select 36").

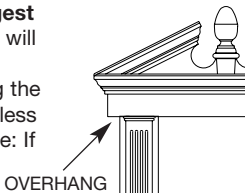

B) Look to see if a "D" Dimension in another column matches your requirements. If so, this will require changing the width of the pilasters as noted at the top of the column above the located "D" Dimension.

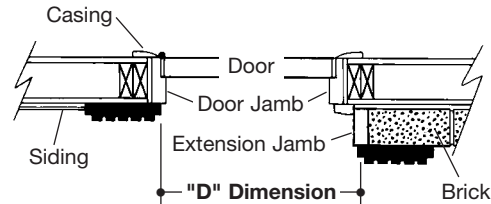

DETAIL 1

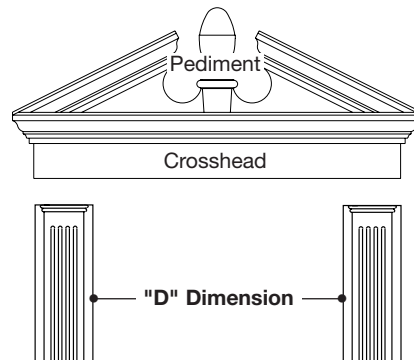

Step 4 Locate the Pilaster Selection Chart (Pages 22 and 23). Using the width as determined by your "D" Dimension, select the style and height as required by your application.

Step 3 To select a crosshead and pediment that will work with the "D" Dimension and pilaster width, move to the right, under the heading "Description". There you will locate the different style crossheads and crossheads & pediments available to fit your application.

Refer to page 20 & 21 for drawings of Crossheads & Combo Crossheads & Pediments.

SAMPLE - Crossheads & Combination Crossheads/Pediments Selection Chart

PILASTER WIDTHS										Description	Item No.	
5"	6"	7"	8"	9"	10"	11"	12"					
Step 2											SINGLE DOOR	
"D" DIMENSIONS											Crosshead w/Trim Strip	350-110-10
Step 2											Crosshead w/Trim Strip	350-110-15
Step 2											Combo Acorn	350-110-20
Step 2											Combo Sunburst	350-110-25
Step 2											Combo Plain	350-110-30
Step 2											Combo Peak	350-110-35
Step 2											Combo Rams Head	350-110-40
Step 2											Combo Broken Bonnet	350-110-45
Step 3											Crosshead w/Trim Strip	350-120-10
"D" DIMENSIONS											Crosshead w/Trim Strip	350-120-15
Step 3											Combo Acorn	350-120-20
Step 3											Combo Sunburst	350-120-25
Step 3											Combo Plain	350-120-30

entrance systems

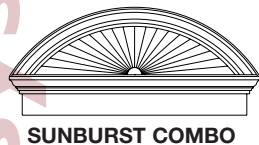

TOWN SERIES

SELECTION CHART for Crossheads & Combination Crossheads/Pediments

PILASTER WIDTHS					Description	Item No.	Bottom Width "B"	Top Width "T"	Height "H"	Proj. "P"	
3 ³ / ₄ "	4 ¹ / ₂ "	5 ¹ / ₄ "	6 ³ / ₄ "	7 ¹ / ₂ "							
SINGLE DOOR OPENINGS											
40"	"D" DIMENSIONS 38 ¹ / ₂ " 37" 34"				32 ¹ / ₂ "	Small Crosshead	350-100-10	47 ¹ / ₂ "	51 ¹ / ₂ "	6"	3"
						Large Crosshead	350-100-15			9"	
						Combo Acorn	350-100-20			20 ³ / ₄ "	
						Combo Sunburst	350-100-25			19 ⁷ / ₈ "	
						Combo Plain	350-100-30			19 ⁷ / ₈ "	
						Combo Peak	350-100-35			19 ⁵ / ₈ "	
						Combo Rams Head	350-100-40			25"	
44 ¹ / ₄ "	"D" DIMENSIONS 42 ³ / ₄ " 41 ¹ / ₄ " 38 ¹ / ₄ "				36 ³ / ₄ "	Small Crosshead	350-110-10	51 ³ / ₄ "	56 ³ / ₄ "	6"	3"
						Large Crosshead	350-110-15			9"	
						Combo Acorn	350-110-20			21 ¹ / ₂ "	
						Combo Sunburst	350-110-25			19 ¹ / ₂ "	
						Combo Plain	350-110-30			19 ¹ / ₂ "	
						Combo Peak	350-110-35			19"	
						Combo Rams Head	350-110-40			25"	
47 ¹ / ₂ "	"D" DIMENSIONS 46" 44 ¹ / ₂ " 41 ¹ / ₂ "				40"	Small Crosshead	350-120-10	55"	59"	6"	3"
						Large Crosshead	350-120-15			9"	
						Combo Acorn	350-120-20			21 ¹ / ₄ "	
						Combo Sunburst	350-120-25			22 ⁵ / ₈ "	
						Combo Plain	350-120-30			22 ⁵ / ₈ "	
						Combo Peak	350-120-35			23 ¹ / ₄ "	
						Combo Rams Head	350-120-40			25 ³ / ₄ "	
59"	"D" DIMENSIONS 57 ¹ / ₂ " 56" 53"				51 ¹ / ₂ "	Small Crosshead	350-130-10	66 ¹ / ₂ "	70 ¹ / ₂ "	6"	3"
						Large Crosshead	350-130-15			9"	
						Combo Acorn	350-130-20			24 ⁷ / ₈ "	
						Combo Sunburst	350-130-25			22 ¹ / ₄ "	
						Combo Plain	350-130-30			22 ¹ / ₄ "	
						Combo Peak	350-130-35			22 ¹ / ₈ "	
						Combo Rams Head	350-130-40			28 ¹ / ₂ "	
68"	"D" DIMENSIONS 66 ¹ / ₂ " 65" 62"				60 ¹ / ₂ "	Small Crosshead	350-140-10	75 ¹ / ₂ "	79 ¹ / ₂ "	6"	3"
						Large Crosshead	350-140-15			9"	
						Combo Acorn	350-140-20			24 ¹ / ₄ "	
						Combo Sunburst	350-140-25			24 ¹ / ₄ "	
						Combo Plain	350-140-30			24 ¹ / ₄ "	
						Combo Peak	350-140-35			25 ¹ / ₈ "	
						Combo Rams Head	350-140-40			28 ¹ / ₂ "	
71 ³ / ₄ "	"D" DIMENSIONS 70 ¹ / ₄ " 68 ³ / ₄ " 65 ³ / ₄ "				64 ¹ / ₄ "	Small Crosshead	350-150-10	79 ¹ / ₄ "	83 ¹ / ₄ "	6"	3"
						Large Crosshead	350-150-15			9"	
						Combo Acorn	350-150-20			24"	
						Combo Sunburst	350-150-25			23 ¹ / ₄ "	
						Combo Plain	350-150-30			24 ¹ / ₄ "	
						Combo Peak	350-150-35			31 ³ / ₄ "	
						Combo Rams Head	350-150-40			28 ⁵ / ₈ "	
75 ³ / ₄ "	"D" DIMENSIONS 74 ¹ / ₄ " 72 ³ / ₄ " 69 ³ / ₄ "				68 ¹ / ₄ "	Small Crosshead	350-160-10	83 ¹ / ₄ "	87 ¹ / ₄ "	6"	3"
						Large Crosshead	350-160-15			9"	
						Combo Acorn	350-160-20			26"	
						Combo Sunburst	350-160-25			25 ¹ / ₄ "	
						Combo Plain	350-160-30			25 ⁵ / ₈ "	
						Combo Peak	350-160-35			25 ⁵ / ₈ "	
						Combo Rams Head	350-160-40			28 ⁵ / ₈ "	

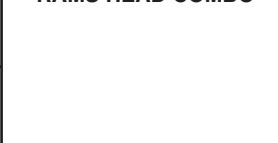
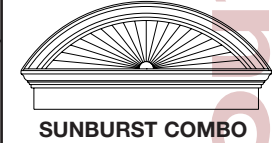

* NOTE: For a 6" & 9" Crosshead with Keystone, add keystone no. after item no. Example: 350-160-10/1155-130.



TOWN SERIES

entrance systems

**351-100
FLUTED
PILASTER**

351-100 & 351-120

Pilasters (stock sizes: 120" and 144") are supplied with loose plinth blocks and can be cut on the job site to accommodate sizes 91" to 120" & 121" to 144".

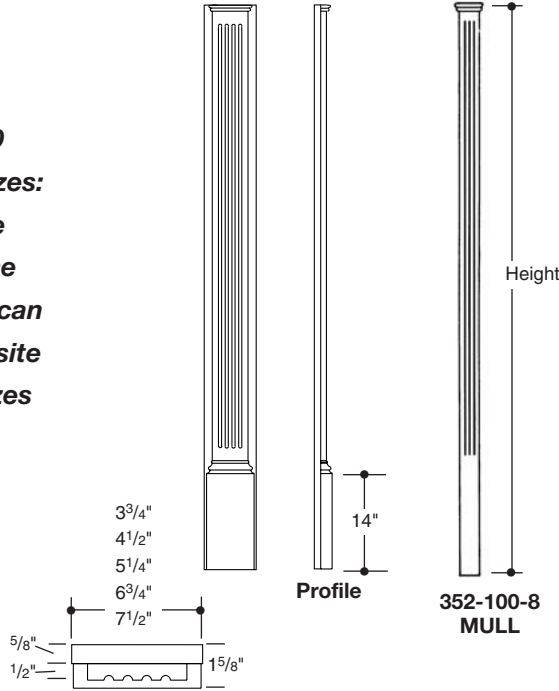

351-100 Pilaster Selection Chart

ITEM NO.	WIDTH	STOCK HEIGHT	CUSTOM HEIGHT
351-100-3-90	3 ³ / ₄ "	90"	-
351-100-3-120*	3 ³ / ₄ "	120"	91"-120"
351-100-3-144*	3 ³ / ₄ "	144"	121"-144"
351-100-4-90	4 ¹ / ₂ "	90"	-
351-100-4-120*	4 ¹ / ₂ "	120"	91"-120"
351-100-4-144*	4 ¹ / ₂ "	144"	121"-144"
351-100-5-90	5 ¹ / ₄ "	90"	-
351-100-5-120*	5 ¹ / ₄ "	120"	91"-120"
351-100-5-144*	5 ¹ / ₄ "	144"	121"-144"
351-100-6-90	6 ³ / ₄ "	90"	-
351-100-6-120*	6 ³ / ₄ "	120"	91"-120"
351-100-6-144*	6 ³ / ₄ "	144"	121"-144"
351-100-7-90	7 ¹ / ₂ "	90"	-
351-100-7-120*	7 ¹ / ₂ "	120"	91"-120"
351-100-7-144*	7 ¹ / ₂ "	144"	121"-144"

* Supplied with loose plinth blocks.

Mulls

ITEM NO.	WIDTH	HEIGHT
352-100-8	1 ¹ / ₂ "	84"

**351-110
PANEL
PILASTER**

351-110 Pilasters are made with fixed plinth blocks. The bottom of the plinth block can be cut to adjust the height.

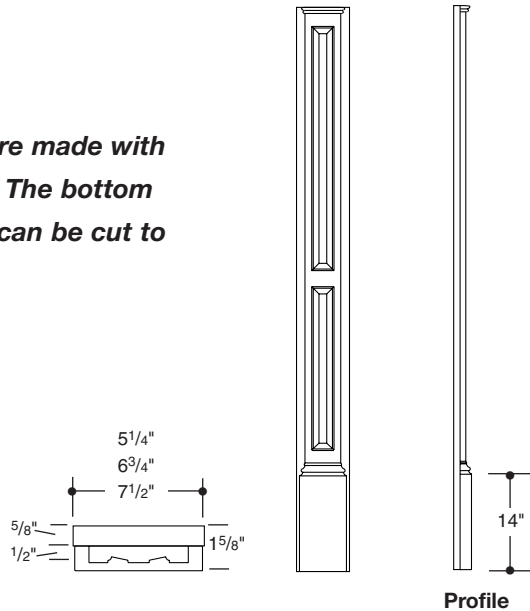

**351-110 Pilaster
Selection Chart**

ITEM NO.	WIDTH	STOCK HEIGHT
351-110-5-90	5 ¹ / ₄ "	90"
351-110-5-120	5 ¹ / ₄ "	120"
351-110-5-144	5 ¹ / ₄ "	144"
351-110-6-90	6 ³ / ₄ "	90"
351-110-6-120	6 ³ / ₄ "	120"
351-110-6-144	6 ³ / ₄ "	144"
351-110-7-90	7 ¹ / ₂ "	90"
351-110-7-120	7 ¹ / ₂ "	120"
351-110-7-144	7 ¹ / ₂ "	144"

TOWN SERIES

**351-120
PLAIN
PILASTER**

**351-100 & 351-120
Pilasters (stock sizes:
120" and 144") are
supplied with loose
plinth blocks and can
be cut on the job
site to accomodate
sizes 91" to 120" &
121" to 144".**

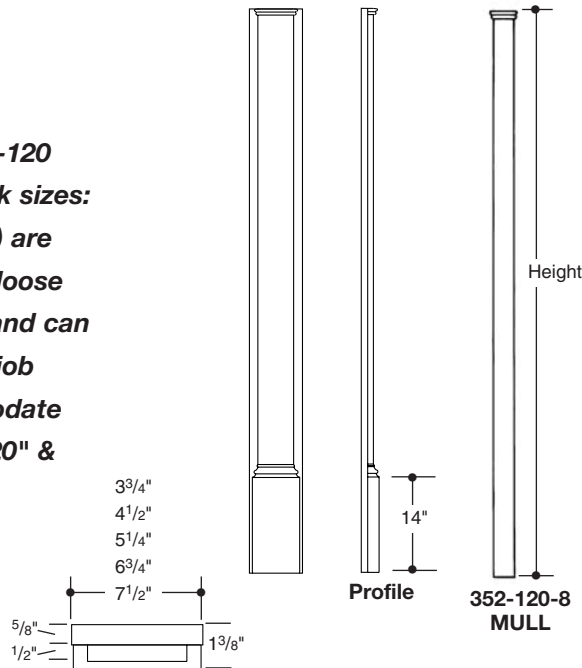

351-120 Pilaster Selection Chart

ITEM NO.	WIDTH	STOCK HEIGHT	CUSTOM HEIGHT
351-120-3-90	3 3/4"	90"	-
351-120-3-120*	3 3/4"	120"	91"-120"
351-120-3-144*	3 3/4"	144"	121"-144"
351-120-4-90	4 1/2"	90"	-
351-120-4-120*	4 1/2"	120"	91"-120"
351-120-4-144*	4 1/2"	144"	121"-144"
351-120-5-90	5 1/4"	90"	-
351-120-5-120*	5 1/4"	120"	91"-120"
351-120-5-144*	5 1/4"	144"	121"-144"
351-120-6-90	6 3/4"	90"	-
351-120-6-120*	6 3/4"	120"	91"-120"
351-120-6-144*	6 3/4"	144"	121"-144"
351-120-7-90	7 1/2"	90"	-
351-120-7-120*	7 1/2"	120"	91"-120"
351-120-7-144*	7 1/2"	144"	121"-144"

* Supplied with loose plinth blocks.

Mulls

ITEM NO.	WIDTH	HEIGHT
352-120-8	1 1/2"	84"

**351-130
PLAIN
PANEL
PILASTER**

**351-130 Pilasters are
made with fixed plinth
blocks. The bottom of the
plinth block can be cut to
adjust the height.**

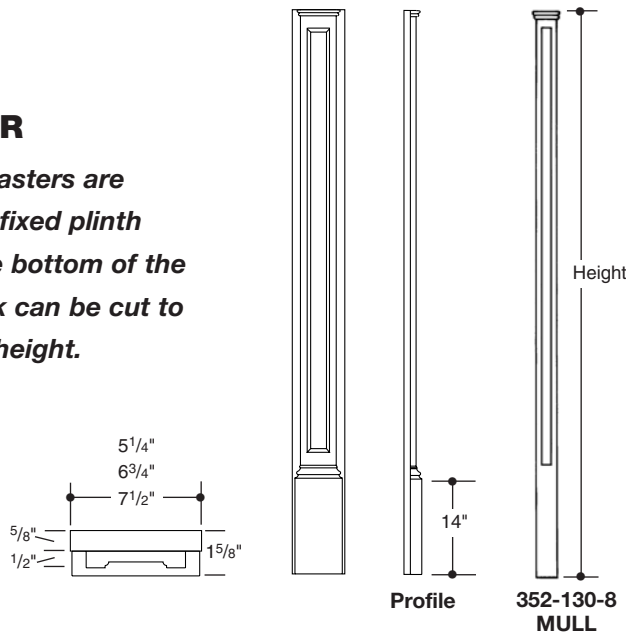

**351-130 Pilaster
Selection Chart**

ITEM NO.	WIDTH	STOCK HEIGHT
351-130-5-90	5 1/4"	90"
351-130-5-120	5 1/4"	120"
351-130-5-144	5 1/4"	144"
351-130-6-90	6 3/4"	90"
351-130-6-120	6 3/4"	120"
351-130-6-144	6 3/4"	144"
351-130-7-90	7 1/2"	90"
351-130-7-120	7 1/2"	120"
351-130-7-144	7 1/2"	144"

Mulls

ITEM NO.	WIDTH	HEIGHT
352-130-8	1 1/2"	84"

**32-160/32-162
LOOSE PLINTH**

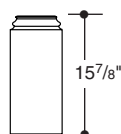

Loose Plinths

ITEM NO.	WIDTH	HEIGHT
353-100-3/353-120-3	4 1/2"	15 7/8"
353-100-4/353-120-4	5 1/4"	
353-100-5/353-120-5	6"	
353-100-6/353-120-6	7 1/2"	
353-100-7/353-120-7	8 1/4"	

NOTE: Specify 353-100-() or 353-120-().

entrance systems

SINGLE SERIES

Order Instructions

Step 1 Determine the "D" Dimension. This is the distance between the inside edge of your pilasters as they will be installed on the door jamb. (SEE DETAIL 1)

Step 2 Locate the Crosshead and Pediment Selection Chart (Page 25 & 26). Under Pilaster Widths, locate your "D" Dimension (See sample at bottom of page). If your "D" Dimension does not match exactly, there are 2 options below (A and B).

A) Select the next largest "D" Dimension, which will usually result in the crosshead overhanging the pilasters by an inch or less on either side. (Example: If your "D" Dimension is 35 1/2" select 36").

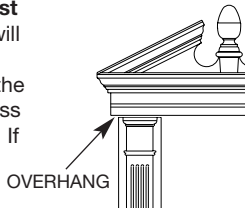

B) Look to see if a "D" Dimension in another column matches your requirements. If so, this will require changing the width of the pilasters as noted at the top of the column above the located "D" Dimension.

Step 3 To select a crosshead and pediment that will work with the "D" Dimension and pilaster width, move to the right, under the heading "Description". There you will locate the different style crossheads and crossheads & pediments available to fit your application.

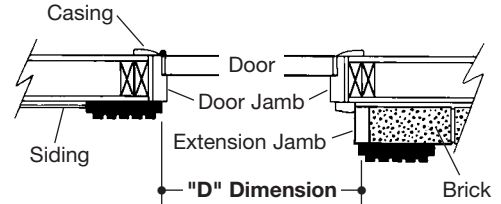

DETAIL 1

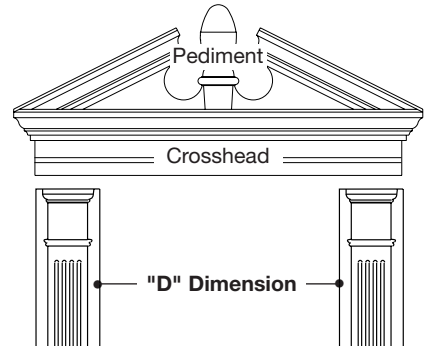

Step 4 Locate the Pilaster Selection Chart (Pages 27 and 28). Using the width as determined by your "D" Dimension, select the style and height as required by your application.

Refer to page 24 & 25 for drawings of Crossheads & Combo Crossheads & Pediments.

SAMPLE - Crossheads & Combination Crossheads/Pediments Selection Chart

PILASTER WIDTHS								Description	Item No.
5"	6"	7"	8"	9"	10"	11"	12"		
SINGLE DOOR									
								Crosshead w/Trim Strip	350-110-10
								Crosshead w/Trim Strip	350-110-15
								Combo Acorn	350-110-20
								Combo Sunburst	350-110-25
								Combo Plain	350-110-30
								Combo Peak	350-110-35
								Combo Rams Head	350-110-40
								Combo Broken Bonnet	350-110-45
								Crosshead w/Trim Strip	350-120-10
								Crosshead w/Trim Strip	350-120-15
								Combo Acorn	350-120-20
								Combo Sunburst	350-120-25
								Combo Plain	350-120-30

Step 2

Step 2

"D" DIMENSIONS

Step 3

"D" DIMENSIONS

entrance systems

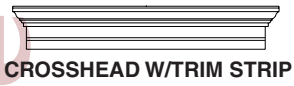
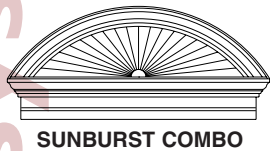

SINGLE SERIES

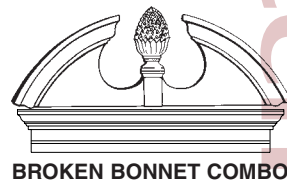
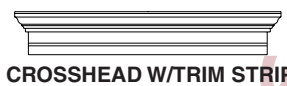
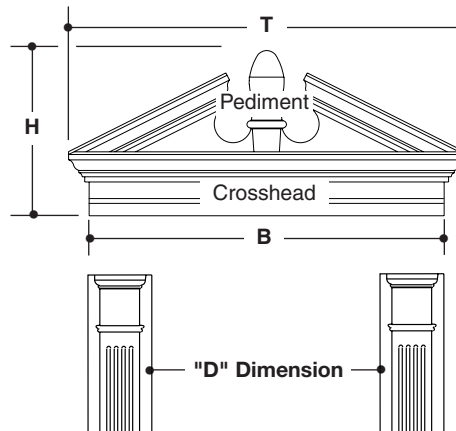

SELECTION CHART for Crossheads & Combination Crossheads/Pediments

PILASTER WIDTHS						Description	Item No.	Bottom Width "B"	Top Width "T"	Height "H"	Proj. "P"
5"	6"	7"	8"	9"	10"						
SINGLE DOOR											
"D" DIMENSIONS	40"	38"	36"	34"	32"	30"	Crosshead w/Trim Strip	350-200-10	50"	55 ³ / ₄ "	9"
							Crosshead w/Trim Strip	350-200-15			11"
							Combo Acorn	350-200-20			23"
							Combo Sunburst	350-200-25			23"
							Combo Plain	350-200-30			23"
							Combo Peak	350-200-35			23"
							Combo Rams Head	350-200-40			29"
							Combo Broken Bonnet	350-200-45			27"
"D" DIMENSIONS	44"	42"	40"	38"	36"	34"	Crosshead w/Trim Strip	350-210-10	54"	59 ³ / ₄ "	9"
							Crosshead w/Trim Strip	350-210-15			11"
							Combo Acorn	350-210-20			24"
							Combo Sunburst	350-210-25			24"
							Combo Plain	350-210-30			24"
							Combo Peak	350-210-35			24"
							Combo Rams Head	350-210-40			30"
							Combo Broken Bonnet	350-210-45			28"
SINGLE DOOR & SINGLE DOOR w/SIDELIGHT											
"D" DIMENSIONS	50"	48"	46"	44"	42"	40"	Crosshead w/Trim Strip	350-220-10	60"	65 ³ / ₄ "	9"
							Crosshead w/Trim Strip	350-220-15			11"
							Combo Acorn	350-220-20			25 ¹ / ₂ "
							Combo Sunburst	350-220-25			25 ¹ / ₂ "
							Combo Plain	350-220-30			25 ¹ / ₂ "
							Combo Peak	350-220-35			25 ¹ / ₂ "
							Combo Rams Head	350-220-40			31 ¹ / ₂ "
							Combo Broken Bonnet	350-220-45			29 ¹ / ₂ "
"D" DIMENSIONS	56"	54"	52"	50"	48"	46"	Crosshead w/Trim Strip	350-230-10	66"	71 ³ / ₄ "	9"
							Crosshead w/Trim Strip	350-230-15			11"
							Combo Acorn	350-230-20			27"
							Combo Sunburst	350-230-25			27"
							Combo Plain	350-230-30			27"
							Combo Peak	350-230-35			27"
							Combo Rams Head	350-230-40			33"
							Combo Broken Bonnet	350-230-45			31"

* NOTE: For a 9" & 11" Crosshead with Keystone, add keystone no. after item no. Example: 350-230-10/1155-130.

entrance systems

SINGLE SERIES

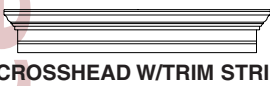
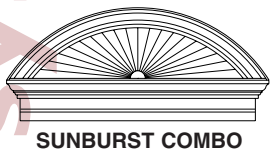
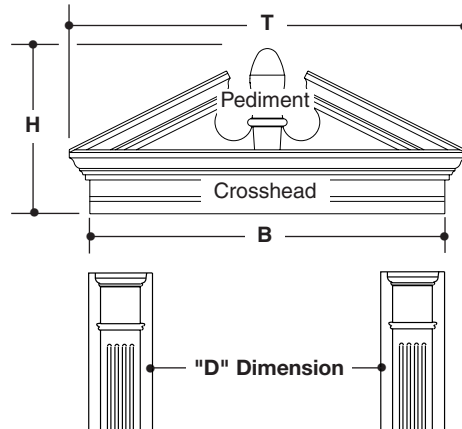

SELECTION CHART for Crossheads & Combination Crossheads/Pediments

PILASTER WIDTHS						Description	Item No.	Bottom Width "B"	Top Width "T"	Height "H"	Proj. "P"
5"	6"	7"	8"	9"	10"						
SINGLE DOOR with 2 SIDELIGHTS & DOUBLE DOORS											
"D" DIMENSIONS						Crosshead w/Trim Strip Crosshead w/Trim Strip Combo Acorn Combo Sunburst Combo Plain Combo Peak Combo Rams Head Combo Broken Bonnet	350-240-10 350-240-15 350-240-20 350-240-25 350-240-30 350-240-35 350-240-40 350-240-45	78"	83 ³ / ₄ "	9"	4"
68"	66"	64"	62"	60"	58"					11"	
										30"	
										30"	
										30"	
										30"	
										36"	
										34"	
"D" DIMENSIONS						Crosshead w/Trim Strip Crosshead w/Trim Strip Combo Acorn Combo Sunburst Combo Plain Combo Peak) Combo Rams Head Combo Broken Bonnet	350-250-10 350-250-15 350-250-20 350-250-25 350-250-30 350-250-35 350-250-40 350-250-45	82"	87 ³ / ₄ "	9"	4"
72"	70"	68"	66"	64"	62"					11"	
										31"	
										31"	
										31"	
										31"	
										37"	
										35"	
"D" DIMENSIONS						Crosshead w/Trim Strip Crosshead w/Trim Strip Combo Acorn Combo Sunburst Combo Plain Combo Peak Combo Rams Head Combo Broken Bonnet	350-260-10 350-260-15 350-260-20 350-260-25 350-260-30 350-260-35 350-260-40 350-260-45	86"	91 ³ / ₄ "	9"	4"
76"	74"	72"	70"	68"	66"					11"	
										32"	
										32"	
										32"	
										32"	
										38"	
										36"	
"D" DIMENSIONS						Crosshead w/Trim Strip Crosshead w/Trim Strip Combo Acorn Combo Sunburst Combo Plain Combo Peak Combo Rams Head Combo Broken Bonnet	350-270-10 350-270-15 350-270-20 350-270-25 350-270-30 350-270-35 350-270-40 350-270-45	94"	99 ³ / ₄ "	9"	4"
84"	82"	80"	78"	76"	74"					11"	
										34"	
										36"	
										34"	
										34"	
										40"	
										38"	

* NOTE: For a 9" & 11" Crosshead with Keystone, add keystone no. after item no. **Example: 350-270-10/1155-130.**

SINGLE SERIES

**351-200
FLUTED
PILASTER**

351-200 & 351-220
Pilasters (stock sizes: 120" and 144") are supplied with loose plinth blocks and can be cut on the job site to accommodate sizes 91" to 120" & 121" to 144".

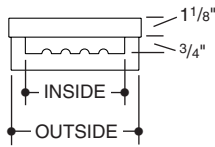

OUTSIDE	INSIDE
5"	3 ³ / ₄ "
6"	4 ¹ / ₂ "
7"	5 ¹ / ₄ "
8"	6"
9"	6 ³ / ₄ "
10"	7 ¹ / ₂ "

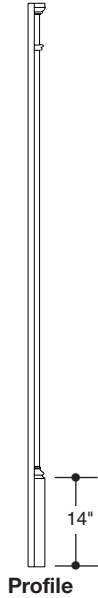
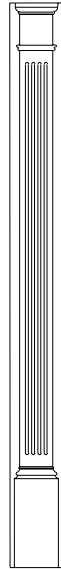

351-200 Pilaster Selection Chart

ITEM NO.	WIDTH	STOCK HEIGHT	CUSTOM HEIGHT
351-200-5-90	5"	90"	-
351-200-5-120*	5"	120"	91"-120"
351-200-6-90	6"	90"	-
351-200-6-120*	6"	120"	91"-120"
351-200-7-90	7"	90"	-
351-200-7-102*	7"	102"	-
351-200-7-116*	7"	116"	-
351-200-7-120*	7"	120"	91"-120"
351-200-7-144*	7"	144"	121"-144"
351-200-8-73*	8"	73"	-
351-200-8-90	8"	90"	-
351-200-8-120*	8"	120"	91"-120"
351-200-8-144*	8"	144"	121"-144"
351-200-9-90	9"	90"	-
351-200-9-102*	9"	102"	-
351-200-9-120*	9"	120"	91"-120"
351-200-9-144*	9"	144"	121"-144"
351-200-10-90	10"	90"	-
351-200-10-120*	10"	120"	91"-120"
351-200-10-144*	10"	144"	121"-144"

* Supplied with loose plinth blocks.

Mulls

ITEM NO.	WIDTH	HEIGHT
352-200-11	2"	84"

**351-210
PANEL
PILASTER**

351-210 Pilasters are made with fixed plinth blocks. The bottom of the plinth block can be cut to adjust the height.

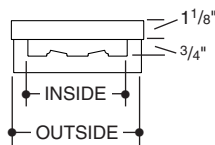

OUTSIDE	INSIDE
7"	5 ¹ / ₄ "
8"	6"
9"	6 ³ / ₄ "
10"	7 ¹ / ₂ "

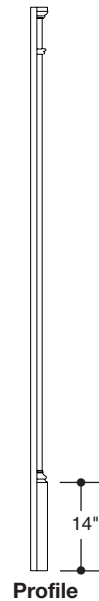
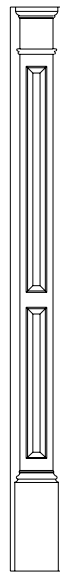

351-210 Pilaster Selection Chart

ITEM NO.	WIDTH	STOCK HEIGHT
351-210-7-90	7"	90"
351-210-7-120	7"	120"
351-210-8-90	8"	90"
351-210-8-120	8"	120"
351-210-9-90	9"	90"
351-210-9-102	9"	102"
351-210-9-120	9"	120"
351-210-10-90	10"	90"
351-210-10-108	10"	108"
351-210-10-120	10"	120"
351-210-10-144	10"	144"

entrance systems



SINGLE SERIES

entrance systems

**351-220
PLAIN
PILASTER**

351-200 & 351-220 Pilasters
(stock sizes: 120" and 144")
are supplied with loose plinth
blocks and can be cut on the
job site to accomodate sizes
91" to 120" & 121" to 144".

OUTSIDE	INSIDE
5"	3 ³ / ₄ "
6"	4 ¹ / ₂ "
7"	5 ¹ / ₄ "
8"	6"
9"	6 ³ / ₄ "
10"	7 ¹ / ₂ "

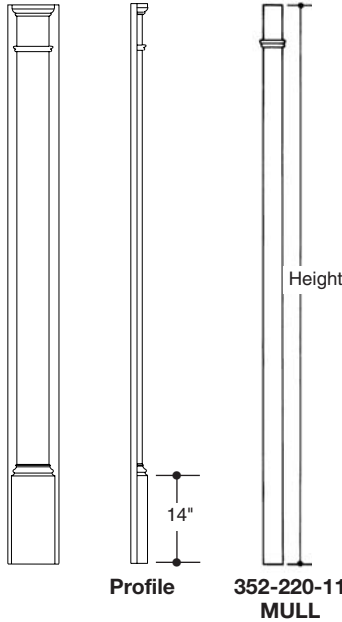

351-220 Pilaster Selection Chart

ITEM NO.	WIDTH	STOCK HEIGHT	CUSTOM HEIGHT
351-220-5-90	5"	90"	-
351-220-5-120*	5"	120"	91"-120"
351-220-6-90	6"	90"	-
351-220-6-120*	6"	120"	91"-120"
351-220-7-90	7"	90"	-
351-220-7-120*	7"	120"	91"-120"
351-220-7-144*	7"	144"	121"-144"
351-220-8-90	8"	90"	-
351-220-8-120*	8"	120"	91"-120"
351-220-8-144*	8"	144"	121"-144"
351-220-9-90	9"	90"	-
351-220-9-120*	9"	120"	91"-120"
351-220-9-144*	9"	144"	121"-144"
351-220-10-90	10"	90"	-
351-220-10-120*	10"	120"	91"-120"
351-220-10-144*	10"	144"	121"-144"

* Supplied with loose plinth blocks.

Mulls

ITEM NO.	WIDTH	HEIGHT
352-220-11	2"	84"

**351-230
PLAIN
PANEL
PILASTER**

351-230 Pilasters are
made with fixed plinth
blocks. The bottom of the
plinth block can be cut to
adjust the height.

OUTSIDE	INSIDE
5"	3 ³ / ₄ "
6"	4 ¹ / ₂ "
7"	5 ¹ / ₄ "
8"	6"
9"	6 ³ / ₄ "
10"	7 ¹ / ₂ "

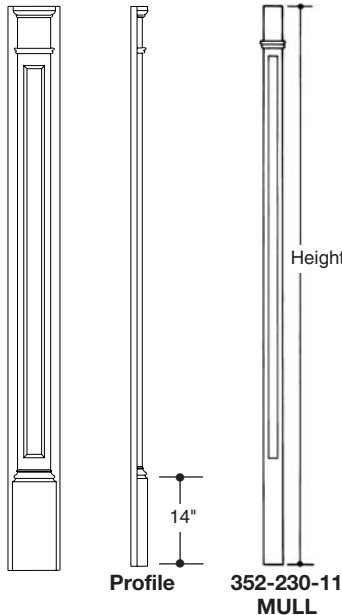

**351-263 Pilaster
Selection Chart**

ITEM NO.	WIDTH	STOCK HEIGHT
351-230-5-90	5"	90"
351-230-6-90	6"	90"
351-230-7-90	7"	90"
351-230-7-120	7"	120"
351-230-8-90	8"	90"
351-230-8-120	8"	120"
351-230-9-90	9"	90"
351-230-9-102	9"	102"
351-230-9-120	9"	120"
351-230-10-90	10"	90"
351-230-10-108	10"	108"
351-230-10-120	10"	120"
351-230-10-144	10"	144"

Mulls

ITEM NO.	WIDTH	HEIGHT
352-230-11	2"	84"

**353-200/353-220
LOOSE PLINTH**

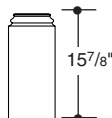

Loose Plinths

ITEM NO.	WIDTH	HEIGHT
353-200-5/353-220-5	5"	15-7/8"
353-200-6/353-220-6	6"	
353-200-7/353-220-7	7"	
353-200-8/353-220-8	8"	
353-200-9/353-220-9	9"	
353-200-10/353-220-10	10"	

NOTE: Specify 353-200-() or 353-220-().

CUSTOM SERIES

Order Instructions

Step 1 Determine the "D" Dimension. This is the distance between the inside edge of your pilasters as they will be installed on the door jamb. (SEE DETAIL 1)

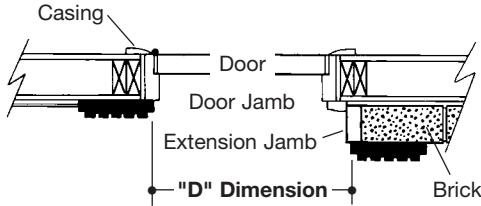

DETAIL 1

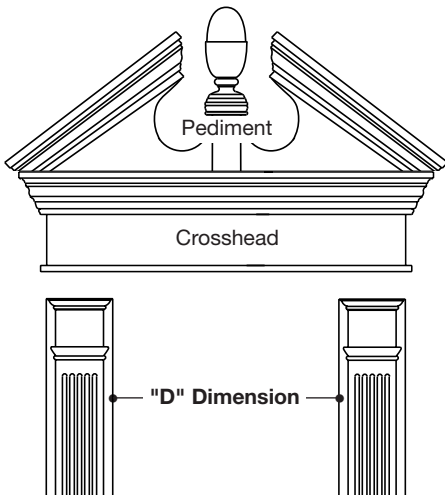

Step 2 Locate the **Crosshead and Pediment Selection Chart** (Page 30 & 31). Under **Pilaster Widths**, locate your "D" Dimension (See sample at bottom of page). If your "D" Dimension does not match exactly, there are 2 options below (A and B).

A) Select the next largest "D" Dimension, which will usually result in the crosshead overhanging the pilasters by an inch or less on either side. (Example: If your "D" Dimension is 35 1/2" select 36").

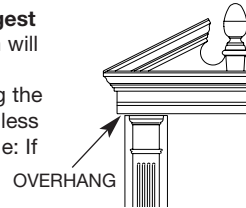

B) Look to see if a "D" Dimension in another column matches your requirements. If so, this will require changing the width of the pilasters as noted at the top of the column above the located "D" Dimension.

Step 3 To select a crosshead and pediment that will work with the "D" Dimension and pilaster width, move to the right, under the heading "Description". There you will locate the different style crossheads and crossheads & pediments available to fit your application.

Step 4 Locate the **Pilaster Selection Chart** (Pages 32 and 33). Using the width as determined by your "D" Dimension, select the style and height as required by your application.

Refer to page 29, 30 & 31 for drawings of Crossheads & Combo Crossheads & Pediments.

SAMPLE - Crossheads & Combination Crossheads/Pediments Selection Chart

PILASTER WIDTHS								Description	Item No.
5"	6"	7"	8"	9"	10"	11"	12"		
								SINGLE DOOR	
"D" DIMENSIONS								Crosshead w/Trim Strip	350-110-10
"D" DIMENSIONS								Crosshead w/Trim Strip	350-110-15
"D" DIMENSIONS								Combo Acorn	350-110-20
"D" DIMENSIONS								Combo Sunburst	350-110-25
"D" DIMENSIONS								Combo Plain	350-110-30
"D" DIMENSIONS								Combo Peak	350-110-35
"D" DIMENSIONS								Combo Rams Head	350-110-40
"D" DIMENSIONS								Combo Broken Bonnet	350-110-45
"D" DIMENSIONS								Crosshead w/Trim Strip	350-120-10
"D" DIMENSIONS								Crosshead w/Trim Strip	350-120-15
"D" DIMENSIONS								Combo Acorn	350-120-20
"D" DIMENSIONS								Combo Sunburst	350-120-25
"D" DIMENSIONS								Combo Plain	350-120-30

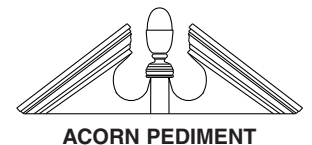
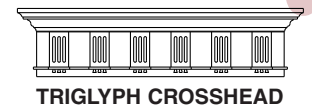
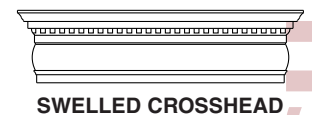
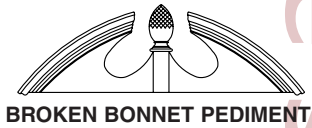
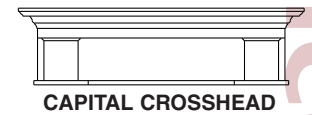
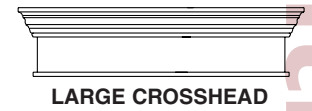

CUSTOM SERIES

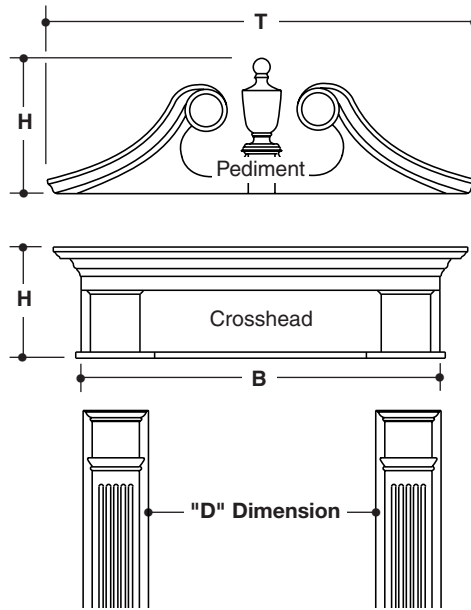
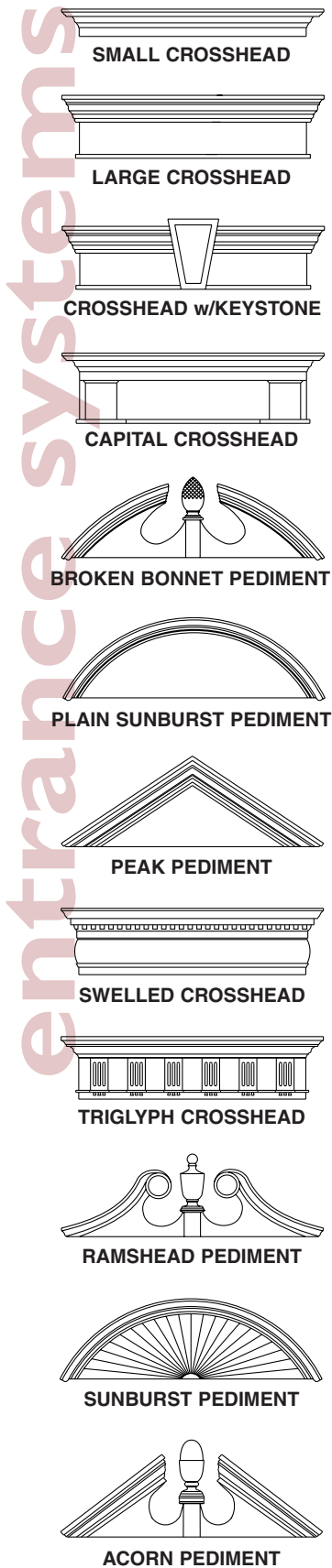

SELECTION CHART for Crossheads & Combination Crossheads/Pediments

PILASTER WIDTHS			Description	Item No.	Bottom Width "B"	Top Width "T"	Height "H"	Proj. "P"			
10"	11"	12"									
SINGLE DOOR											
"D" DIMENSIONS 38"	36"	34"	Capital Crosshead	350-300-65	58"	63"	18"	6"			
			Small Crosshead	350-300-10			7"	6"			
			Large Crosshead	350-300-15			18"	6"			
							Acorn Pediment	350-300-20		26"	6"
							Sunburst Pediment	350-300-25		22"	7"
							Plain Sunburst Pediment	350-300-30		22"	7"
							Peak Pediment	350-300-35		24"	6"
							Rams Head Pediment	350-300-40		20 1/2"	7"
							Broken Bonnet Pediment	350-300-45		22"	7"
							Swelled Crosshead	350-300-50	58"	18"	7"
							Crosshead w/Keystone *	350-300-55		17"	6"
							Triglyph Crosshead	350-300-60		16"	6"
"D" DIMENSIONS 42"	40"	38"	Capital Crosshead	350-310-65	62"	67"	18"	6"			
			Small Crosshead	350-310-10			7"	6"			
			Large Crosshead	350-310-15			18"	6"			
							Acorn Pediment	350-310-20		26"	6"
							Sunburst Pediment	350-310-25		22"	7"
							Plain Sunburst Pediment	350-310-30		22"	7"
							Peak Pediment	350-310-35		24"	6"
							Rams Head Pediment	350-310-40		20 1/2"	7"
							Broken Bonnet Pediment	350-310-45		22"	7"
							Swelled Crosshead	350-310-50	62"	18"	7"
							Crosshead w/Keystone *	350-310-55		17"	6"
							Triglyph Crosshead	350-310-60		16"	6"

CUSTOM SERIES

SELECTION CHART for Crossheads & Combination Crossheads/Pediments

PILASTER WIDTHS			Description	Item No.	Bottom Width "B"	Top Width "T"	Height "H"	Proj. "P"			
10"	11"	12"									
SINGLE DOOR OPENINGS WITH TWO SIDELIGHTS AND DOUBLE DOOR OPENINGS											
"D" DIMENSIONS 62" 60" 58"			Capital Crosshead	350-320-65	82"	87"	18"	6"			
			Small Crosshead	350-320-10			7"	6"			
			Large Crosshead	350-320-15			18"	6"			
						Acorn Pediment	350-320-20	82"	87"	28"	6"
						Sunburst Pediment	350-320-25			21 ³ / ₄ "	7"
						Plain Sunburst Pediment	350-320-30			21 ³ / ₄ "	6"
						Peak Pediment	350-320-35			28"	6"
						Rams Head Pediment	350-320-40			24 ³ / ₄ "	6"
						Broken Bonnet Pediment	350-320-45			27"	7"
						Swelled Crosshead	350-320-50			17"	6"
						Crosshead w/Keystone	350-320-55			18"	6"
						Triglyph Crosshead	350-320-60			18 ¹ / ₂ "	6"
						"D" DIMENSIONS 66" 64" 62"				Capital Crosshead	350-330-65
Small Crosshead	350-330-10	7"	6"								
Large Crosshead	350-330-15	18"	6"								
			Acorn Pediment	350-330-20	86"				91"	28"	6"
			Sunburst Pediment	350-330-25						21 ³ / ₄ "	7"
			Plain Sunburst Pediment	350-330-30						21 ³ / ₄ "	6"
			Peak Pediment	350-330-35						28"	6"
			Rams Head Pediment	350-330-40						24 ³ / ₄ "	6"
			Broken Bonnet Pediment	350-330-45						27"	7"
			Swelled Crosshead	350-330-50						17"	6"
			Crosshead w/Keystone	350-330-55						18"	6"
			Triglyph Crosshead	350-330-60						18 ¹ / ₂ "	6"
			"D" DIMENSIONS 70" 68" 66"							Capital Crosshead	350-340-65
Small Crosshead	350-340-10	7"				6"					
Large Crosshead	350-340-15	18"				6"					
						Acorn Pediment	350-340-20	90"	95"	30"	6"
						Sunburst Pediment	350-340-25			30"	7"
						Plain Sunburst Pediment	350-340-30			30"	7"
						Peak Pediment	350-340-35			30"	6"
						Rams Head Pediment	350-340-40			26 ³ / ₄ "	7"
						Broken Bonnet Pediment	350-340-45			30"	7"
						Swelled Crosshead	350-340-50			17"	6"
						Crosshead w/Keystone	350-340-55			18"	6"
						Triglyph Crosshead	350-340-60			18 ¹ / ₂ "	6"
						"D" DIMENSIONS 74" 72" 70"				Capital Crosshead	350-350-65
Small Crosshead	350-350-10	7"	6"								
Large Crosshead	350-350-15	18"	6"								
			Acorn Pediment	350-350-20	94"				99"	30"	6"
			Sunburst Pediment	350-350-25						30"	7"
			Plain Sunburst Pediment	350-350-30						30"	7"
			Peak Pediment	350-350-35						30"	6"
			Rams Head Pediment	350-350-40						26 ³ / ₄ "	7"
			Broken Bonnet Pediment	350-350-45						30"	7"
			Swelled Crosshead	350-350-50						17"	6"
			Crosshead w/Keystone	350-350-55						18"	6"
			Triglyph Crosshead	350-350-60						18 ¹ / ₂ "	6"
			CUSTOM OPENINGS								
Varies			Capital Crosshead	350-360-65	95"-192"	198" or less	18"	6"			
			Small Crosshead	350-360-10	95"-144"	150" or less	7"	6"			
			Large Crosshead	350-360-15	95"-192"	198" or less	18"	6"			
			Acorn Pediment	350-360-20	-	144" or less	varies	6"			
			Peak Pediment	350-360-35	-	156" or less	varies	4 ¹ / ₄ "			
			Rams Head Pediment	350-360-40	-	146"	36"	7"			
			Swelled Crosshead	350-360-50	100"	105"	18"	6"			

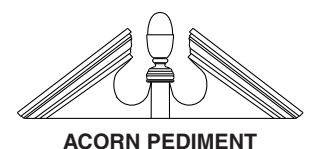
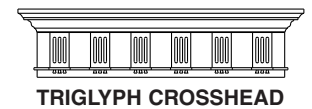
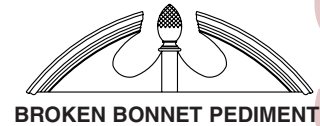
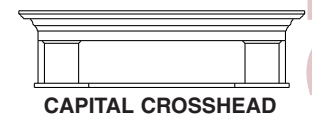
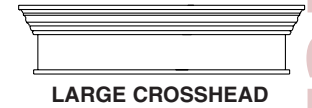

entrance systems



CUSTOM SERIES

entrance systems

**351-300
FLUTED
PILASTER**

351-300 & 351-320

Pilasters (stock sizes: 120" and 144") are supplied with loose plinth blocks and can be cut on the job site to accommodate sizes 91" to 120" & 121" to 144".

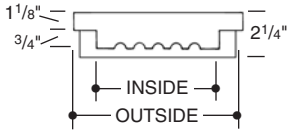

OUTSIDE	INSIDE
10"	7 1/2"
11"	8 1/4"
12"	9"

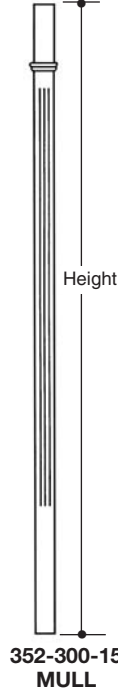
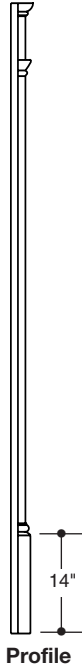
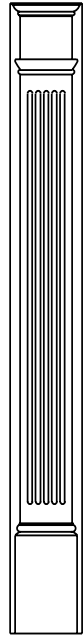

351-300 Pilaster Selection Chart

ITEM NO.	WIDTH	STOCK HEIGHT	CUSTOM HEIGHT
351-300-10-90	10"	90"	-
351-300-10-108*	10"	108"	91"-108"
351-300-10-120*	10"	120"	108"-120"
351-300-10-144*	10"	144"	121"-144"
351-300-11-90	11"	90"	-
351-300-11-108*	11"	108"	91"-108"
351-300-11-120*	11"	120"	108"-120"
351-300-11-144*	11"	144"	121"-144"
351-300-12-90	12"	90"	-
351-300-12-108*	12"	108"	91"-108"
351-300-12-120*	12"	120"	108"-120"
351-300-12-144*	12"	144"	121"-144"

* Supplied with loose plinth blocks.

Mulls

ITEM NO.	WIDTH	HEIGHT
352-300-15	2"	84"

**351-310
PANEL
PILASTER**

351-310 Pilasters are made with fixed plinth blocks. The bottom of the plinth block can be cut to adjust the height.

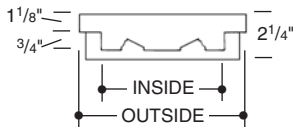

OUTSIDE	INSIDE
10"	7 1/2"
11"	8 1/4"
12"	9"

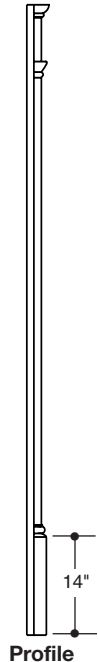
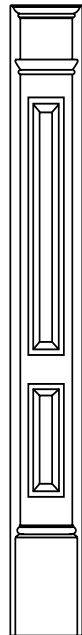

351-310 Pilaster Selection Chart

ITEM NO.	WIDTH	STOCK HEIGHT
351-310-10-90	10"	90"
351-310-10-108	10"	108"
351-310-10-120	10"	120"
351-310-10-144	10"	144"
351-310-11-90	11"	90"
351-310-11-108	11"	108"
351-310-11-120	11"	120"
351-310-11-144	11"	144"
351-310-12-90	12"	90"
351-310-12-108	12"	108"
351-310-12-120	12"	120"
351-310-12-144	12"	144"



CUSTOM SERIES

**351-320
PLAIN
PILASTER**

351-300 & 351-320 Pilasters
(stock sizes: 120" and 144")
are supplied with loose plinth
blocks and can be cut on the
job site to accommodate sizes
91" to 120" & 121" to 144".

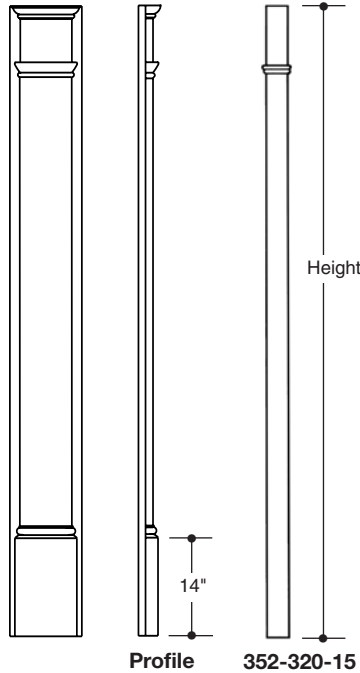
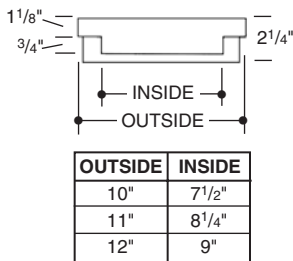

351-320 Pilaster Selection Chart

ITEM NO.	WIDTH	STOCK HEIGHT	CUSTOM HEIGHT
351-320-10-90	10"	90"	-
351-320-10-108*	10"	108"	91"-108"
351-320-10-120*	10"	120"	108"-120"
351-320-10-144*	10"	144"	121"-144"
351-320-11-90	11"	90"	-
351-320-11-108*	11"	108"	91"-108"
351-320-11-120*	11"	120"	108"-120"
351-320-11-144*	11"	144"	121"-144"
351-320-12-90	12"	90"	-
351-320-12-108*	12"	108"	91"-108"
351-320-12-120*	12"	120"	108"-120"
351-320-12-144*	12"	144"	121"-144"

* Supplied with loose plinth blocks.

Mulls

ITEM NO.	WIDTH	HEIGHT
352-320-15	2"	84"

**351-330
PLAIN
PANEL
PILASTER**

351-330 Pilasters are
made with fixed plinth
blocks. The bottom of the
plinth block can be cut to
adjust the height.

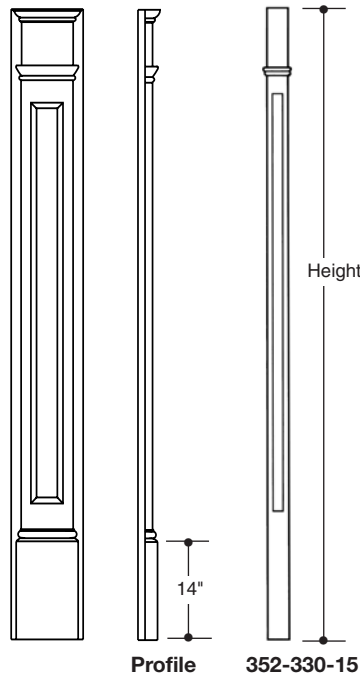
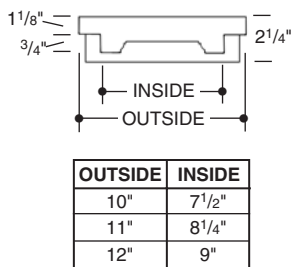

**351-330 Pilaster
Selection Chart**

ITEM NO.	WIDTH	STOCK HEIGHT
351-330-10-90	10"	90"
351-330-10-108	10"	108"
351-330-10-120	10"	120"
351-330-10-144	10"	144"
351-330-11-90	11"	90"
351-330-11-108	11"	108"
351-330-11-120	11"	120"
351-330-11-144	11"	144"
351-330-12-90	12"	90"
351-330-12-108	12"	108"
351-330-12-120	12"	120"
351-330-12-144	12"	144"

Mulls

ITEM NO.	WIDTH	HEIGHT
352-330-15	2"	84"

**353-300/353-320
LOOSE PLINTH**

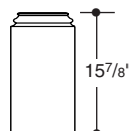

Loose Plinths

ITEM NO.	WIDTH	HEIGHT
353-300-10/353-320-10	10"	15 7/8"
353-300-11/353-320-11	11"	
353-300-12/353-320-12	12"	

NOTE: Specify 353-300-() or 353-320-().

entrance systems



entrances



354-100-14-36 Victorian Pediment

354-100-14-40 Victorian Pediment

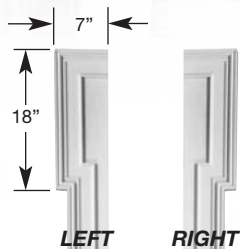
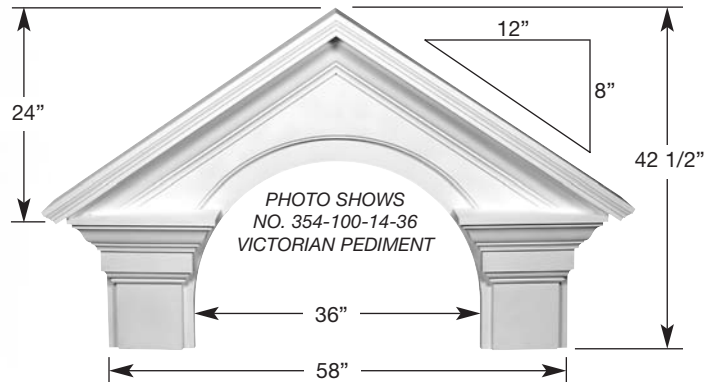

550-328-8
Pilaster

Length: 8'
Matches
550-328 Molding

Pilasters to Fit
Victorian Pediment

Item No.
351-300-11-90
351-300-11-108
351-300-11-120
351-310-11-90
351-310-11-108
351-310-11-120
351-320-11-90
351-320-11-108
351-320-11-120
351-330-11-90
351-330-11-108
351-330-11-120

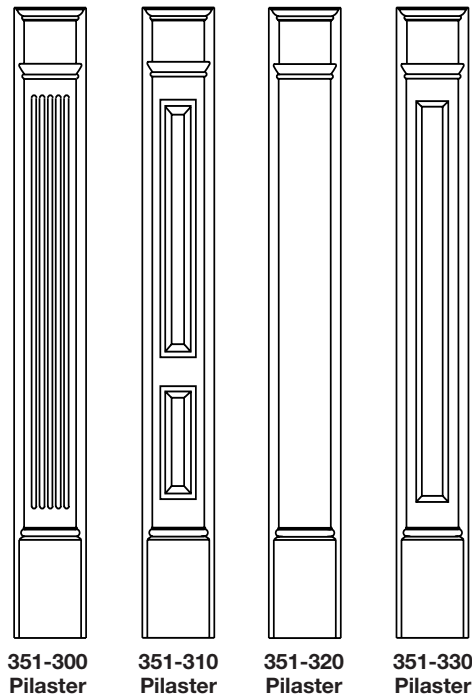

354-190 Plinth

Height: 18"
Width: 10 3/8"
Proj.: 2 7/8"

550-190-E Door Trim

Length: 8'
Matches
550-180 Molding

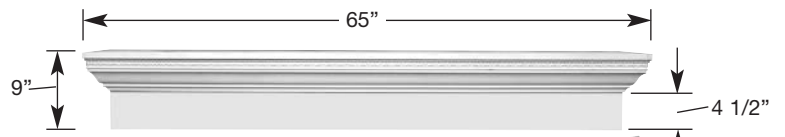

354-200-10 Victorian Mantel

Height: 9"
Width: 65"
Proj.: 16"



550-190-T Door Trim Top

Length: 96" Matches 550-180 Molding