

LOUVERS

Available in a variety of shapes and sizes, Melton Classics offers just the right Architectural Urethane™ louver to enhance any architectural style. Louvers are offered in ventilating and non-ventilating designs. Functional venting louvers have openings between the slats and are covered on the rear with non-corrosive screening to allow unobstructed air flow and keep insects out. Decorative non-ventilating louvers are provided in one solid piece and do not allow air to flow through them. Decorative casings and keystones are available to enhance the appearance of Architectural Urethane™ louvers. Louvers are also available routed to accept siding upon request.

NOTE: It is important to know that all open urethane louvers may allow water seepage during severe weather conditions. We recommend a flash pan be installed behind the louver to catch any water seepage.

See Installation Instructions for Complete details.

Melton Classics will offer to “route” louvers for siding applications. Please specify the dimensions required for your application. See additional cost for routing.

Numbering System:

Louver - Style - Width - Height
450 - 120 - 12 - 24

Louvers can be routed so that siding fits behind for a professional application.

EXAMPLE OF ROUTING EDGE.

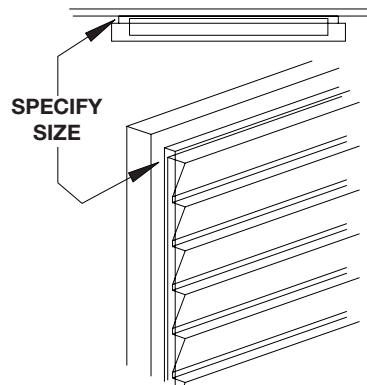

No. 450-120, No. 450-125
Circle Top Louver

Closed	Open w/screen
450-120-12-24	450-125-12-24
450-120-13-57	450-125-13-57
450-120-18-30	450-125-18-30
450-120-22-32	450-125-22-32
450-120-24-48	450-125-24-48
450-120-36-48	450-125-36-48



No. 450-100, No. 450-105
Octagon Louver

Closed	Open w/screen
450-100-12	450-105-12
450-100-18	450-105-18
450-100-22	450-105-22
450-100-24	450-105-24
450-100-30	450-105-30

FLAT TRIM FOR LOUVERS
3-1/2" or 5-1/2" Flat Trim can be added to Louvers.
Call for price.

louvers



LOUVERS

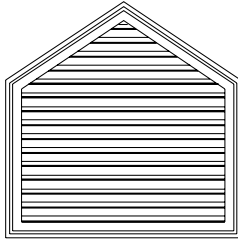

No. 450-200, No. 450-205
Peak Louver

Pitch	Closed		Open w/screen	
	Width	Height	Width	Height
4.5	450-200-36-34	450-205-36-34		
5	450-200-36-15.5	450-205-36-15.5		
6	450-200-40-32	450-205-40-32		
7	450-200-30-40	450-205-30-40		
7	450-200-48-40	450-205-48-40		
8	450-200-30-30	450-205-30-30		
9	450-200-28-31.5	450-205-28-31.5		
10	450-200-24-30	450-205-24-30		
12	450-200-24-36	450-205-24-36		
12	450-200-24-54	450-205-24-54		

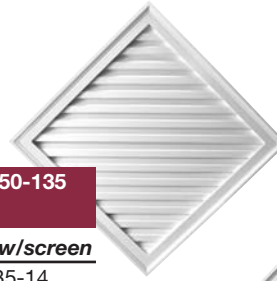

No. 450-130, No. 450-135
Diamond Louver

Closed	Open w/screen
450-130-14	450-135-14
450-130-24	450-135-24



No. 450-260, No. 450-265
Triangle Louver

Pitch	Closed	Open w/screen
4.5	450-260-4.5-48	450-265-4.5-48
5	450-260-5-48	450-265-5-48
5	450-260-5-84	450-265-5-84
6	450-260-6-48	450-265-6-48
6	450-260-6-76	450-265-6-76
6	450-260-6-88	450-265-6-88
6	450-260-6-120	450-265-6-120
7	450-260-7-60	450-265-7-60
8	450-260-8-64	450-265-8-64
9	450-260-9-60	450-265-9-60
9	450-260-9-120	450-265-9-120
10	450-260-10-64	450-265-10-64
12	450-260-12-42	450-265-12-42
12	450-260-12-64	450-265-12-64
14	450-260-14-60	450-265-14-60
16	450-260-16-54	450-265-16-54

FLAT TRIM FOR LOUVERS
3-1/2" or 5-1/2" Flat Trim can be added to Louvers.
Call for price.



No. 450-170, No. 451-175
Half round keystone louver

Closed	Open w/screen
450-170-36	450-175-36
450-170-42	450-175-42
450-170-48	450-175-48
450-170-60	450-175-60



No. 450-210, No. 450-215
Round Louver w/Trim

Closed	Open w/screen
450-210-20	450-215-20
450-210-27	450-215-27
450-210-34	450-215-34



No. 450-150, No. 450-155
Half Round Louver

Closed	Open w/screen
450-150-22	40-155-22
450-150-24	40-155-24
450-150-32	40-155-32
450-150-36	40-155-36
450-150-40	40-155-40
450-150-44	40-155-44
450-150-48	40-155-48
450-150-52	40-155-52
450-150-60	40-155-60
450-150-72	40-155-72



No. 450-140, No. 450-145
Eyebrow Louver

Closed	Open w/screen		
Width	Height	Width	Height
450-140-12-24	40-145-12-24		
450-140-18-30	40-145-18-30		
450-140-22-32	40-145-22-32		

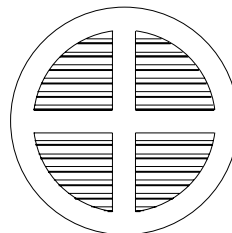

No. 450-110, No. 450-115
Round Cross Louver

Closed	Open w/screen
450-110-30	450-115-30-0



LOUVERS

louvers



No. 450-270
Vertical oval louver

Closed	Open w/screen
450-270-34	40-275-34

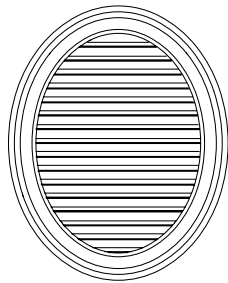

No. 450-280, No. 450-285
Vertical Oval Louver

Closed	Open w/screen
450-280-35	450-285-35

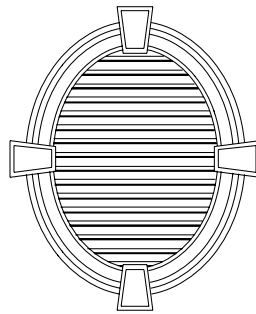

No. 450-290, No. 450-295
Vertical Oval Keystone Louver

Closed	Open w/screen
450-290-35	450-295-35



No. 450-250, No. 450-255
Rectangle Louver

Closed		Open w/screen	
Width	Height	Width	Height
450-250-9	59	450-255-9	59
450-250-11	12	450-255-11	12
450-250-12	18	450-255-12	18
450-250-12	36	450-255-12	36
450-250-12	24	450-255-12	24
450-250-14	32	450-255-14	32
450-250-16	24	450-255-16	24
450-250-16	36	450-255-16	36
450-250-18	24	450-255-18	24
450-250-18	30	450-255-18	30
450-250-18	42	450-255-18	42
450-250-24	30	450-255-24	30
450-250-24	36	450-255-24	36
450-250-24	48	450-255-24	48
450-250-28	57	450-255-28	57
450-250-30	42	450-255-30	42
450-250-44	48	450-255-44	48



No. 450-180, No. 450-185
Horizontal Oval Louver

Closed	Open w/screen
450-180-28	450-185-28
450-180-41	450-185-41

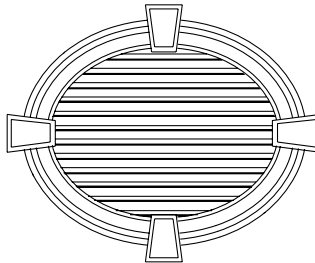

No. 450-190, No. 450-195
Horizontal Oval Keystone Louver

Closed	Open w/screen
450-190-28	450-195-28
450-190-41	450-195-41



No. 450-160, No. 450-165
Round Keystone Louver

Closed	Open w/screen
450-160-16	450-165-16
450-160-18	450-165-18
450-160-24	450-165-24
450-160-30	450-165-30
450-160-32	450-165-32
450-160-36	450-165-36
450-160-40	450-165-40
450-160-60	450-165-60

FLAT TRIM FOR LOUVERS
3-1/2" or 5-1/2" Flat Trim can be added to Louvers.
Call for price.



No. 450-240, No. 450-245
Round Louver

Closed	Open w/screen
450-240-12	450-245-12
450-240-15	450-245-15
450-240-18	450-245-18
450-240-22	450-245-22
450-240-24	450-245-24
450-240-28	450-245-28
450-240-30	450-245-30
450-240-36	450-245-36
450-240-42	450-245-42
450-240-48	450-245-48
450-240-60	450-245-60

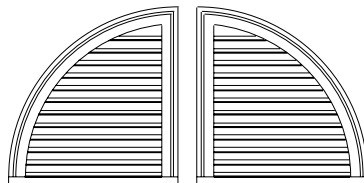

No. 450-220, No. 450-225
Quarter Round Louvers

Closed	Open w/screen
450-220-24	450-225-24
450-220-36	450-225-36
450-220-44	450-225-44

Note: Quarter Round Louvers sold as sets (left & right).